

# Model ESMH

---

MOTORIZED FORCE MEASUREMENT TEST STAND

## User's Guide

**Thanks!**

Thank you for purchasing a Mark-10 Model ESMH motorized test stand. We are confident that you will get many years of great service from this product.

Mark-10 test stands and load frames are ruggedly built for many years of service in laboratory and industrial environments.

This User's Guide provides unpacking, setup, and operator instructions, along with specifications and dimensions. For additional information or answers to your questions, our technical support and engineering teams will be eager to help you.

Thank you again for your purchase and happy testing!

**TABLE OF CONTENTS**

INTRODUCTION .....2

UNPACKING .....2

SAFETY TIPS.....3

SETUP .....3

OPERATION .....5

SPECIFICATIONS.....7

DIMENSIONS .....8

TEST STANDS BY MARK-10 .....9

FORCE GAUGES BY MARK-10 .....10

WARRANTY .....10

**FORCE GAUGES BY MARK-10**

**Capacities from 0.12 lb (0.5 N) to 1,000 lb (5,000 N)**



**Force Gauges Series EG**

- Reversible aluminum housing for hand-held use or stand mounting
- Three units of measurement: lb, kg, N
- Programmable initial status of units and mode of operation
- Automatic peak memory
- Push-button calibration
- Battery or AC operation with programmable automatic shutoff
- Permanent configuration memory
- Optional RS-232, Mitutoyo and analog outputs



**Force Gauges Series BG** (in addition to EG features)

- RS-232, Mitutoyo and analog outputs
- GCL – Gauge Control Language for full control of all functions
- Automatic timed output on RS-232
- Dual set points with outputs
- General purpose I/O for external device control
- Programmable analog and digital filters
- Averaging mode for obtaining average force readings over time



**Force Gauges Series MG**

- Low cost and small size
- Aluminum housing is reversible for hand-held use or test stand mounting
- Peak memory for tensile and compressive loads
- Selectable units of measurement programmable auto shutoff
- Push-button calibration
- IPM - Intelligent Power Management system for reliable operation

**WARRANTY**

Mark-10 Corporation expressly warrants to its buyer for three (3) years from the date of delivery that the goods sold are free from defects in workmanship and materials. Mark-10 Corporation will, at its option, repair or replace or refund the purchase price of goods found to be defective. This remedy shall be the buyer's sole and exclusive remedy. Any modification, abuse, exposure to corrosive environment or use other than intended will void this warranty. This warranty is in lieu of all other warranties, including implied warranties of merchantability and fitness for an intended purpose. In no event shall Mark-10 Corporation be liable for any incidental and consequential damages in connection with goods sold or any part thereof.

## TEST STANDS BY MARK-10

*Manual and motorized, up to 1,000 lb and 100 lbin*



**TSAH**  
Manual, Force  
Lever  
750 lb

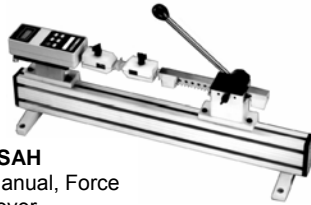

**TSB**  
Manual, Force  
Lever  
100 lb



**TSTM**  
Motorized, Torque  
100 lbin



**TSF**  
Manual, Force  
Hand wheel  
1,000 lb



**TSA**  
Manual, Force  
Lever  
750 lb

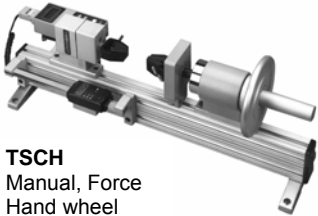

**TSCH**  
Manual, Force  
Hand wheel  
1,000 lb



**ES10**  
Manual, Force  
Lever  
100 lb

**ES20**  
Manual, Force  
Hand wheel  
100 lb



**ES30**  
Manual, Force  
Hand wheel  
200 lb

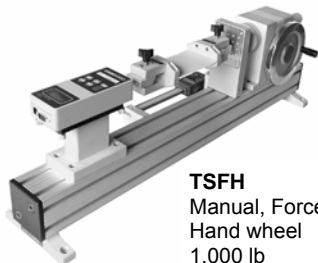

**TSFH**  
Manual, Force  
Hand wheel  
1,000 lb



**ESM**  
Motorized, Force  
200 lb

## INTRODUCTION

The ESMH motorized test stand is a horizontal force measurement tester designed to test up to 50 lb [250 N] of tensile or compressive force. The ESMH works in conjunction with a force gauge and gripping fixtures. Common applications include peel testing, small spring testing, coefficient of friction testing, and other product performance testing.

## UNPACKING

Carefully unpack the contents and inspect for any damage. Check the contents to ensure that you have received all of the items listed below:

Quantity	Item
1	Test stand
1	Controller
1	Power cord
1	Grip mounting plate
4	Screws for grip mounting plate
4	Thumb screws for force gauge mounting
1	User's guide (this booklet)
1	Tool kit
1	Accessories set (small hook, medium hook, 2" diameter compression plate, 2" extension rod, and #10-32 coupler)

### Optional items

Part No.	Description
ESMH001	Digital travel display kit (with separate user's guide)

## SAFETY TIPS



- Wear eye and face protection when testing. Although the ESMH has relatively slow moving mechanisms, be aware of the dangers posed by potential energy that can accumulate in a sample during testing.
- Keep away from the moving parts of the test stand.
- Never operate the test stand if there is any visible damage to the power cord or the control unit. The ESMH is powered by 110/220V AC current that is present in both the power cord and the control unit. Any contact with this high voltage can cause serious injury or even death.
- Ensure that the control unit is kept away from water or any other liquids at all times.
- Make sure the electrical outlet powering the test stand has local earth ground (3-hole outlet).
- Opening up the cover of the control unit is not recommended, as there are no user-serviceable parts inside. If you wish to open it, be sure to disconnect power before doing so. If any repairs are needed, contact Mark-10 or your distributor.

## SETUP

### Mounting to a workbench

Place the ESMH on a clean, flat and level work area that meets the criteria outlined in the work area safety instructions. For accurate readings, the area should be free of vibrations.

If desired, the test stand can be mounted to the work area with four 5/16 screws.

## DIMENSIONS

IN [MM]

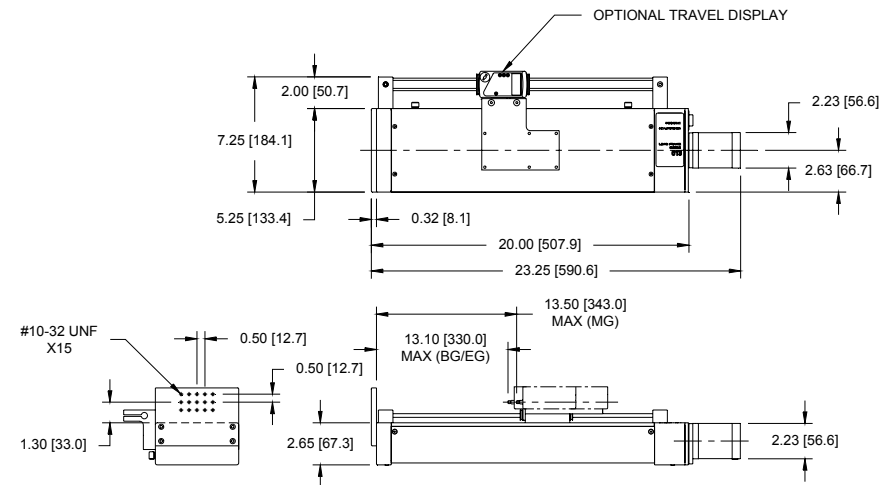

**About the digital travel display (optional)**

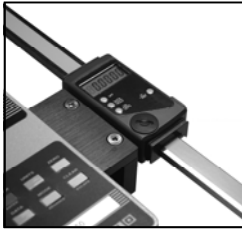

The travel display covers 12" of travel with a 5-digit display (0.0005" resolution) and a computer interface for automated data collection. Use cable P/N 09-1066 to output data to a PC.

Complete instructions are provided in a separate user's guide (included with the digital travel display).

**SPECIFICATIONS**

Load capacity:	50 lb [250 N]
Speed range:	0.2-50 in/min [5-1270 mm/min]
Speed accuracy:	±5% of setting, ±0% variation with load
Maximum travel:	13.0 in [330.2 mm]
Maximum travel w/travel display:	12.0 in [304.8 mm]
Power:	Universal input 80-240 VAC, 50/60 Hz
Fuse type:	1.2 A, 250V, 3AG SLO BLO
Weight (test stand only):	17 lb [7.7 kg]
Controller weight:	2.7 lb [1.2 kg]

**Mounting force gauges**

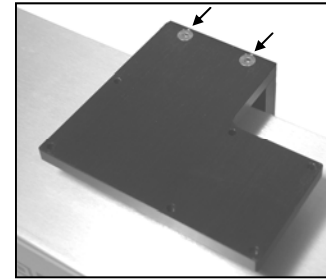

To mount a force gauge, it is necessary to temporarily remove the gauge adapter from the crosshead. Loosen the two 5/16 screws (shown at left) using the included tool kit. Then, mount the gauge to the adapter using the four included gauge mounting screws. After the gauge is mounted to the adapter, mount the adapter back onto the crosshead with the 5/16 screws.

**Mounting grips and fixtures**

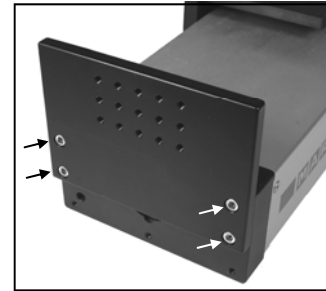

The ESMH includes a loading plate to which a grip or fixture may be mounted. This plate can be mounted to the end of the stand with four screws (shown at left). Before mounting the loading plate, mount the grip or fixture to it, using the matrix of tapped holes if required.

**Setting up the controller**

Plug the controller cable into the 9-pin male connector located beside the motor. See illustration below.

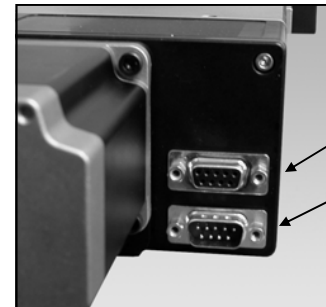

Connector for optional set point cable / overload protection module

Connector for controller

## OPERATION

### Using the controller

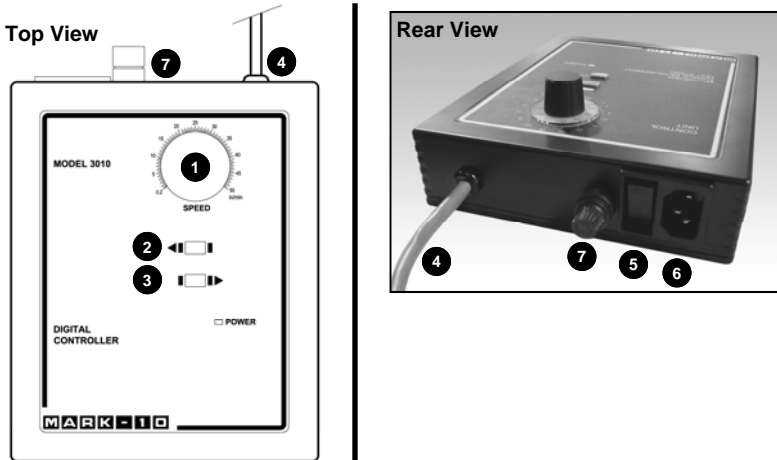

#### 1. SPEED CONTROL DIAL

Adjust speed by turning the dial 0.2 – 50.0 in/min [5 – 1270 mm/min].

#### 2. LEFT

Press and hold to move the crosshead to the left, producing compressive force. Release button to stop motion.

#### 3. RIGHT

Press and hold to move the crosshead to the right, producing tensile force. Release button to stop motion.

#### 4. CONTROLLER CABLE

Plug this cable into the lower connector on the test stand, adjacent to the motor.

#### 5. POWER SWITCH

Use this switch to turn on and turn off power to the load frame. Power is indicated by illuminated indicators on the face of the controller and load frame.

#### 6. POWER PLUG RECEPTACLE

Plug the power cord in here.

#### 7. FUSE

1.2 A, 250V, 3AG SLO BLO

**Note:** To maintain smooth functioning of the stand, avoid overloads.

### Powering up

Plug the power cord into the controller and the other end into a wall outlet. Then turn on power with the power switch (see Page 5).

### Reading the indicators

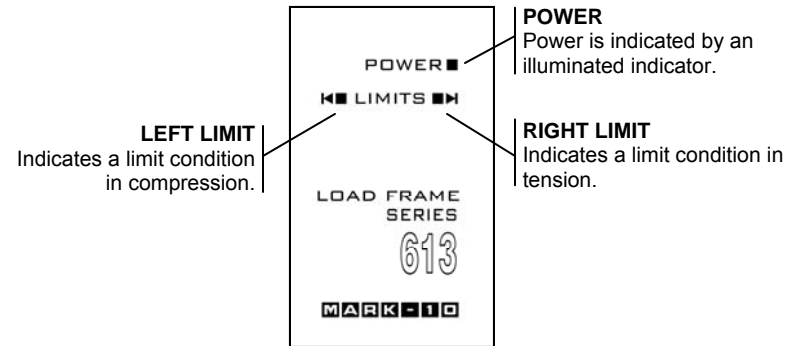

### Using the limit switches

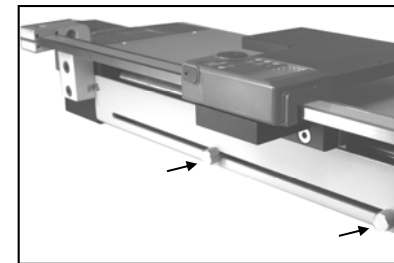

Limit switches are included to allow the operator to set travel limits during testing. This feature is particularly useful for spring testing, elongation testing, and other applications where stopping at a predetermined position is a requirement.

The limit switches are located in the rear of the load frame. Their positions can be adjusted by loosening the thumbscrews (shown at left), sliding them to either side, and re-tightening. During testing, when a travel limit has been reached, an indicator will be illuminated (see illustration above) and the crosshead movement will stop.