

## 2 YEAR WARRANTY (RESTRICTIONS APPLY)

Hoto Instruments warrants its products to the original purchaser to be free from defects in workmanship and material under normal use and proper maintenance for two years (one year for attachments, adapters, batteries, and cables) from original purchase. This warranty shall not be effective if the product has been subject to overload, shock load, misuse, negligence, accident or repairs attempted by others than Hoto Instruments.

During the warranty period, we will, at our option, either repair or replace defective products. Please call our customer service department for a return authorization number and return the defective product to us with freight prepaid.

The foregoing warranty constitutes the SOLE AND EXCLUSIVE WARRANTY, and we hereby disclaim all other warranties, express, statutory or implied, applicable to the products, including but not limited to all implied warranties of merchantability and fitness. In no event shall Hoto Instruments be liable for any incidental or consequential damages.

# Model ESL-20 LED Stroboscope

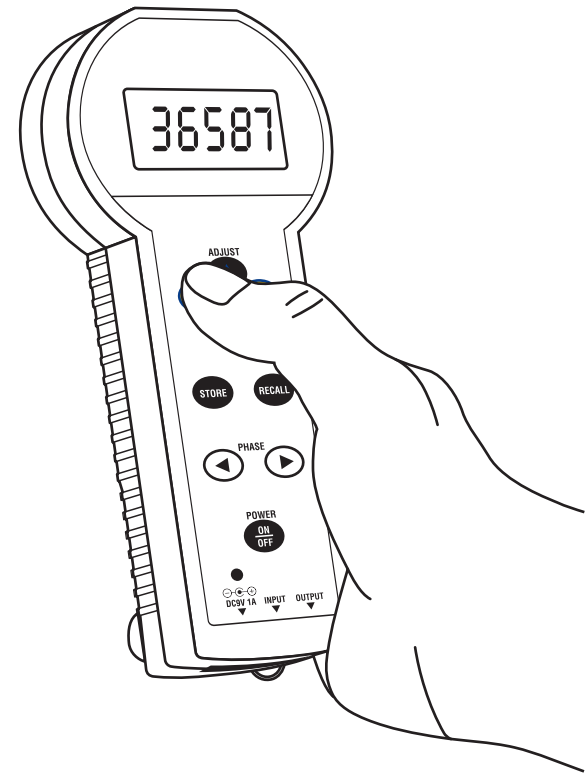

# Model ESL-20 LED Stroboscope

## Introduction

Model ESL-20 is an enhanced LED array, battery operated, stroboscope designed to measure and observe rotating, reciprocating and linear motion in a large variety of production, quality control and academic applications.

- Enhanced LED array with 96 lights
- 0 to 120,000 flashes per minute with floating decimal display
- LEDs never need replacements
- Extended battery life – 10 hours continuous use at 6,000 rpm/fpm
- Rate Multiplier(x2)/Divider(÷2) for fast synchronization and true rpm confirmation
- 19 non-volatile data memory, last reading recall
- External Trigger
- Digital Phase Shift by 1° increments
- Rugged Aluminum Housing

## Important

Do not look directly at the emitted light.  
Instrument is fragile – handle with care.  
Do not operate instrument in a humid or dusty environment.  
To clean, wipe surface with a damp, soapy cloth. Avoid harsh chemicals.

## Operation

1. When you receive your ESL-20 it may not be fully charged. Connect the unit to the AC adapter/charger; a full charge takes about 6 hours. Automatic shutoff prevents overcharging. The AC adapter/charger may be used to operate the strobe but the battery is not charged during operation.
2. The ESL-20 can be handheld or tripod mounted. When mounting the unit, the tripod screw (1/4-20UNC) should not exceed 8mm.
3. Visually note a unique feature or physically mark the object to be measured with reflective tape or a chalk mark.
4. Press the **POWER** switch, the power icon will flash on the display and the strobe will flash at 3,000 fpm (factory default) or the previous power down value.

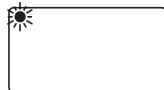

## Dimensions

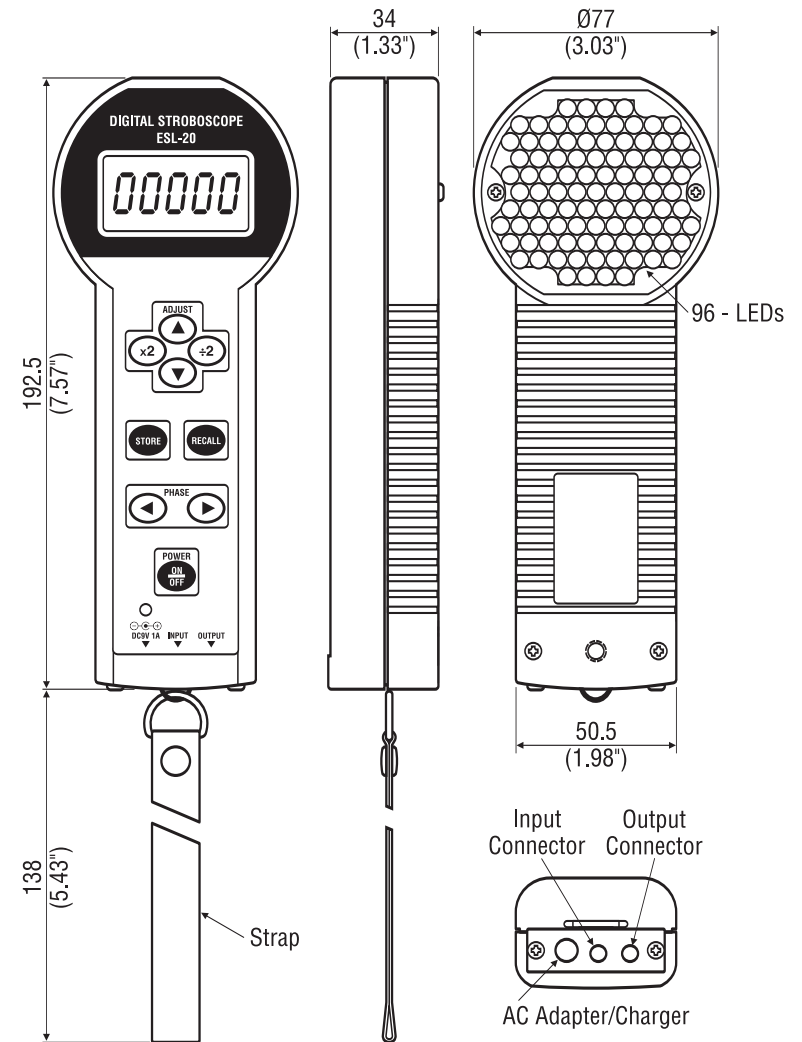

Specifications subject to change without notice.

## Recharging the Battery

**IMPORTANT!** Use the provided AC adapter/charger exclusively and plug into the correct AC output; others will cause damage.



When the Battery icon flashes on the display, turn off the unit and connect to the AC adapter/charger. The indicator light near the On/Off button will flash and turn solid as the unit is charged. The indicator will go off when the stroboscope is fully charged.

## Specifications

Range	Resolution
6.0 – 9999.9 fpm/rpm	±0.1 fpm/rpm
10000 – 120000 fpm/rpm	±1 fpm/rpm Display flashes over 100000 rpm
> 120000 fpm/rpm	“E” on Display (Strobe cut-off)

Accuracy	±0.007%, ±1LSD
Power	NiMH rechargeable battery
Display	12mm, 5 digit LCD
Light Source	LED Array
Phase Shift	0 – 359° in 1° increments
Flash Rate Coarse Adjust	Press x2 or ÷2
Flash Rate Fine Adjust	Press v or ^ (adjustable rate)
Synchronous Output	NPN Open collector 30V, 10mA max., 100 µs pulse width
Synchronous Input	Low level: 0~0.8VDC, High level: 2.5~30VDC, 50µs minimum pulse width, negative edge trigger
Tripod Thread	¼ - 20 UNC
Operating Temperature	0 – 45°C
Storage Temperature	-10 – 50°C
Weight	1.2 lb/540 g
Standard Accessories	Carrying case, AC Adapter/Charger

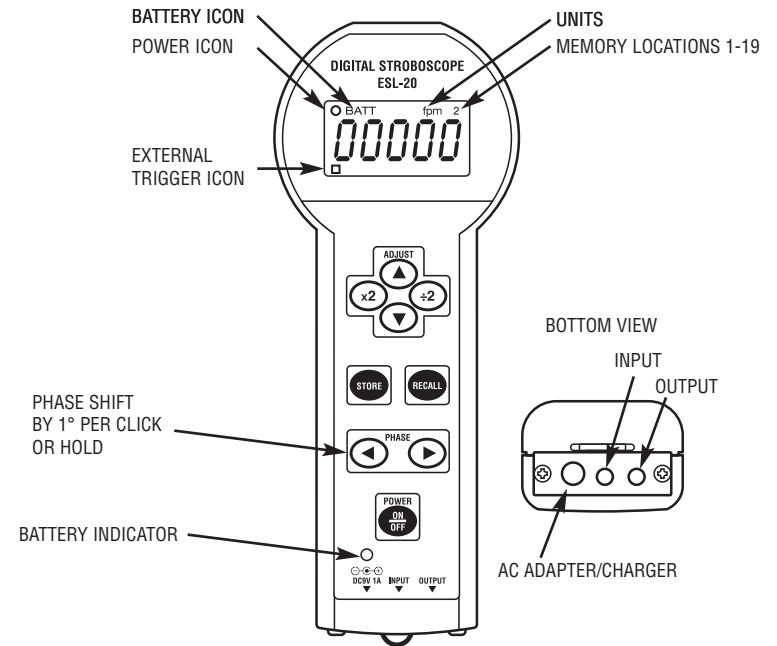

4. Aim the ESL-20 at object. To approximate true rpm, rapidly increase the flash rate by pressing **x2** until multiple images of the feature or mark appear almost frozen.

Use **^** or **v** to adjust the flash rate until the images of the feature or mark appear frozen.

By holding **^** or **v** switch, the flash rate changes more rapidly the longer the switch is held down, then resets 1.5 seconds after it is released.

**Advanced users:** After you release the **^** or **v** switch, the rate of change is indicated by a flashing digit.

The place of the flashing digit advances from second to third as the switch is held longer. While a digit is flashing, press the phase shift switches **<** or **>** to move the place of the flashing digit higher or lower. Then press **^** or **v** switch to change the flash rate by that amount.

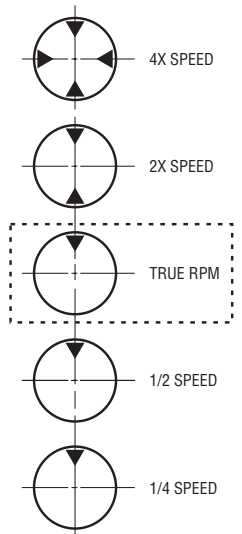

5. Confirm true rpm by pressing **÷2** until a single image appears. Then press **÷2** again. If a single image appears again, press **x2** for true rpm. If true rpm cannot be confirmed repeat steps four and five.

## Memory Store & Recall

### Memory Functions

Press **STORE** to save up to 19 flash rates. When **STORE** is pressed the memory location number in the upper right corner of the display and the value flashes to confirm storage. Data is saved to the next available memory location until 19 values are stored and no more data can be saved. Press **RECALL** to cycle through stored measurements. The memory location numbers appear in the upper right corner of the display.

### Referencing Memory to Physical Locations

To reference your tests to specific memory locations, first activate the required number of locations by storing data (any value) in them. Then press **RECALL** until the memory location number appears, adjust the flash rate and press **STORE** to overwrite the current value. Using this method, numbered machinery or processes may be referenced to corresponding memory location numbers and recalled for quick retests so only fine adjustments to the flash rate are necessary.

### Clear Memory

With power on, simultaneously press **STORE** and **RECALL** for a minimum of four seconds. The display will show a row of dashes and all memory locations will be erased. To erase an individual memory press **RECALL** to select a specific memory location, adjust the flash rate, then press **STORE**.

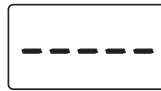

### Power Management

After your stroboscope is set to a constant flash rate, the instrument will automatically power off after two minutes. Press any key except **POWER** to extend the operating time another two minutes.

To disable power management, turn off the unit, then press and hold **STORE** while pressing **POWER**. The Power icon flashes during normal operation and remains steady when power management is off.

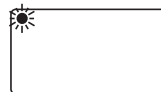

POWER  
MANAGEMENT ON



POWER  
MANAGEMENT OFF

### External Triggering Input

Insert a 3.5mm phone plug into the base of the strobe. See diagram and specifications for details.

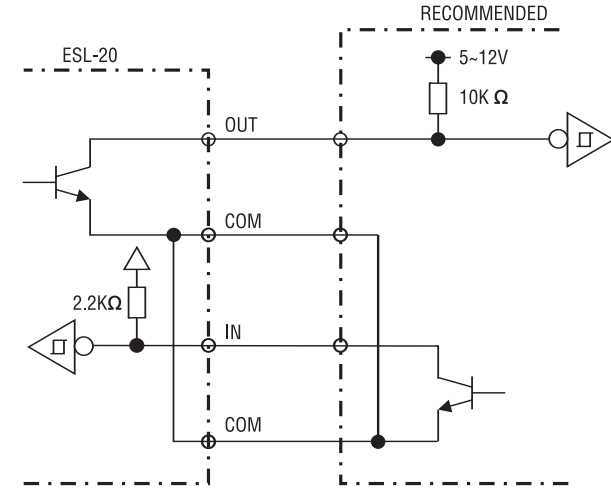
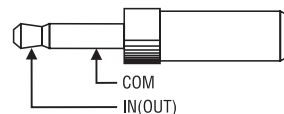

When the strobe receives an input signal, the External Trigger icon flashes at the bottom left of the display. The strobe's flash rate corresponds to the frequency of the input signal. The display will indicate this rate in flashes per minute. To disable External Trigger Mode, turn off the strobe and remove the input plug.



EXTERNAL TRIGGER ICON

To synchronize two ESL-20 stroboscopes, connect one ESL-20 output port to the other strobe's input port (this one will be the slave).

### Digital Phase Shift

The input signal's cycle is 360°. Alternatively, the delayed angle of the input cycle can be viewed and displayed by adjusting the **>** and **<** keys. The range of this adjustment (phase shift) is 0 to 359°. Three seconds after the phase angle is set the display will return to flashes per minute, while maintaining the phase shift setting. When the instrument is switched off, the phase shift setting is reset to zero.